

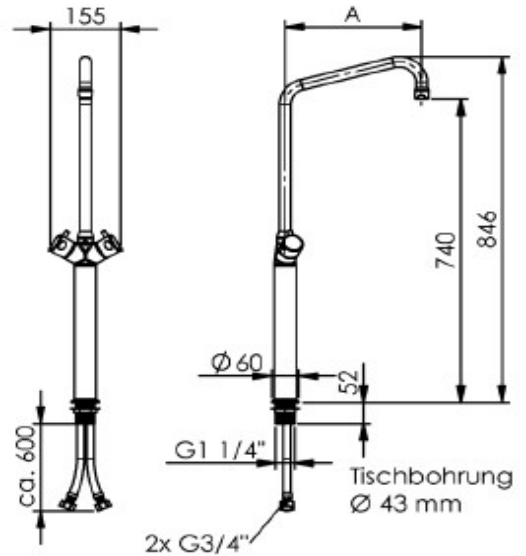

Robinet col de cygne 3/4" monotrou mélangeur
Inox 316L

Réf: 0210528-I



Fabrication Allemande



- Mélangeur à commande 1/4 tour
- Corps et tête de robinet en inox 316L
- Col de cygne avec système anti-goutte
- Poignée Thermo-isolante

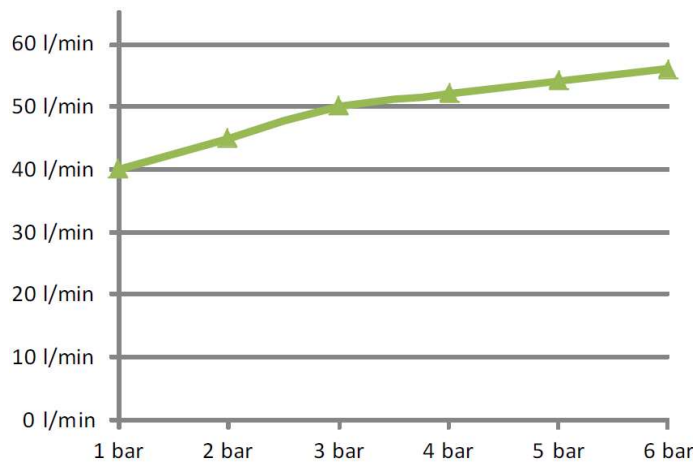

| | |
|---------------------------|---------------------|
| Référence EPCI | 0210528-I |
| Longueur de col de cygne | A= 500 mm |
| Hauteur totale | 846 mm |
| Hauteur sous col de cygne | 740 mm |
| Raccordement | G3/4 |
| Débit d'eau | 50 L (3 Bar) |
| Garantie | 15 ans (corps inox) |
| Finition | Inox 316 L MAT |